



The Atom™ Plus Wireless LED Light

The Atom™ Plus Wireless LED Light System

REF 90803-001

Instructions For Use

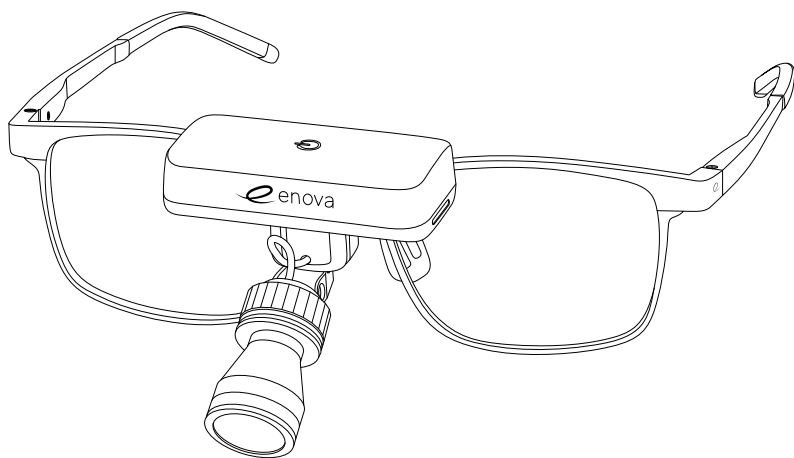

Introduction

This *Instructions For Use* manual is the most comprehensive source of information for the safe and effective use of your product. This manual may be used by surgeons, dentists, veterinarians, or other healthcare professionals.

Keep and consult this reference manual during the life of the product.

The following conventions are used in this manual:

- A **WARNING** highlights a safety-related issue. ALWAYS comply with this information to prevent injury to patient, user, medical personnel, and/or other persons and animals.
- A **CAUTION** highlights a product reliability issue. ALWAYS comply with this information to prevent product damage.
- A **NOTE** supplements and/or clarifies procedural information.

If additional information, especially safety information, or in-service training is required, contact your Enova sales representative or call Enova customer service.

Trademarks not the property of Enova Illumination, Inc are the property of their respective owners.

Indications for Use

The Atom Plus Light uses a lithium-polymer battery and LED light source to offer perfect ultra-lightweight mobility to reduce the discomforts of wired headlamps. It was designed to be used by attaching directly to most loupes. The use of a wireless light gives the user complete portability allowing unrestricted movement. The wireless light is intended to be used to illuminate oral structure, affected areas, or minor surgery areas.

Contraindications

None known.

Limitations of Use

None known.

For Use With

Approved surgical loupes, rechargeable battery packs, charging cable and charging pad. See *Accessories* section.

User / Patient Safety



WARNINGS:

- Do not use any third-party chargers with Atom Plus Light Battery Packs, even if they look identical. Third-party chargers are not compatible with the battery packs and could damage them.
- Avoid intentional or unintentional contact of the batteries to each other or with a conductive surface. This will cause irreparable damage to the battery and is **STRONGLY DISCOURAGED**.
- Avoid direct sunlight or heated surfaces to prevent battery packs from overheating.
- Do not use close to explosive or highly flammable materials like alcohol, methanol, acetone, etc.
- Avoid shock to product by keeping product in approved composite carrying case when not in use.
- **DO NOT** use the LED surgical headlight, power packs, or charging pads in explosive gas environments.
- **DO NOT** autoclave, immerse or submerge in liquid, spray with liquids or leave the LED "on" when inside the composite carrying case as it will cause damage to the Atom Plus Light or may cause a fire.
- Please consult local regulations for the disposal of electronic products and rechargeable lithium batteries.

Accessories

This section describes components that may be ordered to replace original equipment that is damaged, worn, or must be replaced.



WARNINGS:

- Use only Enova-approved components and accessories, including power packs, unless otherwise specified.
- DO NOT modify any component or accessory, unless otherwise specified.

The following Enova-approved accessories can be sold in conjunction with the Atom Plus Wireless LED Light System:

DESCRIPTION	REF
LED Light Module	80801-XXX
2 Battery Packs	80801-002
Charging Pad	80801-003
UV Filter	80801-004
USB C Charging Cable	80801-005
Screwdriver	80801-006
Charging Plug (Input: DC 5V, 1A)	80801-007

NOTE: For a complete list of accessories, contact your Enova sales representative or call Enova customer service.

NOTE: Additional adapters may be available. Please contact your Enova representative or customer service for assistance.

Inspection and Testing



WARNING:

- Only individuals trained and experienced in the maintenance of medical devices should test and service this equipment.
- DO NOT use any equipment if damage is apparent or the inspection criteria are not met.
- DO NOT disassemble or service this equipment, unless otherwise specified.

NOTE: For service, contact your Enova sales representative or call Enova customer service.

INTERVAL	INSPECTION CRITERIA	ACTION
Before Use	Inspect equipment for damage, wear, or missing components.	If damage is apparent, replace the equipment
	Inspect USB Charging Cable and Headlight Cable for cuts, punctures, or kinks.	
	Inspect headlight lens for scratches.	
	Inspect the power pack housing for cracks.	

Features

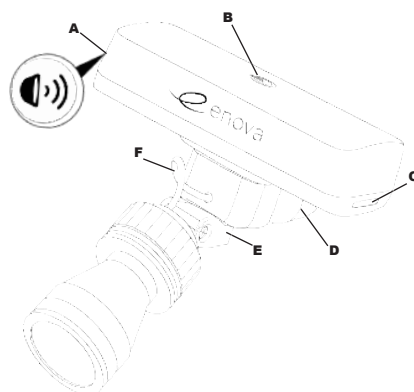

A	Light Intensity Control: Touch Capacitive to control three light intensities.
B	Power Pack Control: Provides power to light. Touch capacitive to turn light ON or OFF.
C	Battery Charge Indicator Light: An indication of battery charge level.
D	Magnetic Loupe Adapter: This adapter attaches the light to the frames or loupes.
E	Light Adjustment Bracket: This bracket is used to adjust the light beam to fit coaxially to the line of sight.
F	Headlight Cable: Connects the light source to the battery connection pad.

Instructions

CAUTIONS:

- Perform recommended inspection and testing as indicated in the *Inspection and Testing* section.
- ALWAYS operate the equipment within the specified environmental conditions. See the *User/Patient Safety* section.
- This equipment is suitable to use in a professional healthcare facility environment.
- When attempting to place the single battery pack in reverse position, the magnets will not allow it to be attached to the connection pad. Failure to connect batteries to charging pad or light correctly may result in product damage.
- DO NOT cut or puncture the headlight cable.
- ALWAYS remove battery after use
- DO NOT scratch the LED headlight lens.

To Charge the Battery

1. Connect USB C Cable to the Enova-supplied Charging Plug provided (Figure 1).
2. Plug the Charging Plug (Input: DC 5V, 1A) into wall outlet (Figure 2).
3. Plug the USB C cable into the charging pad (Figure 3).
4. Place a single battery on the charging pad. It is possible to charge two battery packs simultaneously (Figure 4).
5. The charging indicator will light red. The indicator will change to green when the battery is fully charged.
6. The battery pack, when low or out of power, will flash an indicator light red and beep (alarm) if the power button/area is touched, indicating a charge is needed.

NOTE: Battery packs may remain on the charging pad when not in use. However, it is recommended to remove batteries when fully charged to maintain longevity.

NOTE: The battery packs are delivered at a partial charge. The batteries must be fully charged before first use.

Single Battery Packs

Each Atom Plus Wireless Light System includes two single battery pack units serving as the power source and control panel for the headlight. The battery packs will only work once connected to the connection pad on the light.

1. To turn the light system ON or OFF, use the touch capacitive control. See *Features* section.
2. To brighten or dim the light source, touch the side panel of the battery. The Atom Plus has three intensities. See *Features* section.

NOTE: The battery pack supports a constant level of intensity during the whole period of discharging. Once the battery is fully discharged, the light turns off.

To Use Atom Plus Wireless Light

1. When applicable, mount the external UV Filter onto the front part of the light source by pushing the outer ring of the filter onto the front body of the light source. Fasten with a screw driver. (Figure 5).
2. Attach the Atom Plus Light to the loupe or frame using the magnetic adapter or universal clip.
3. Place a single battery pack on the connection pad. The battery pack must be oriented with Enova logo facing ahead. The magnets will align the battery electrodes with the connection pad (Figure 6).
4. Once aligned correctly, touch the power control to turn light ON (Figure 7).
5. Adjust light intensity to your preference using the touch capacitive control. See *Features* section.
6. Adjust angle of the light so light beam is visible through frames (Figure 8).
7. After use, touch the power pack's power control to turn the power off.

NOTE: When attempting to place the single battery pack in reverse position, the magnets will not allow it to be attached to the connection pad or light.

Troubleshooting



WARNING: DO NOT service this equipment, unless otherwise specified. If you require service, contact your Enova sales representative, certified Enova distributor, or call Enova customer service.

Issue	Troubleshooting
The light does not work steadily due to discharged battery	Replace battery pack. Charge the discharged battery
LED is flickering or dim after full charge	Check electrode connection, if problem persists, contact Enova
LED failure	Contact Enova representative immediately
Battery does not function	
Battery leakage	
Battery swelling	
Battery overheats or produces fire during charge	

Instructions for Atom Plus Wireless Light

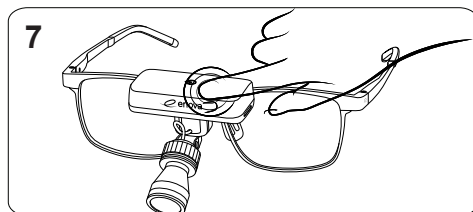
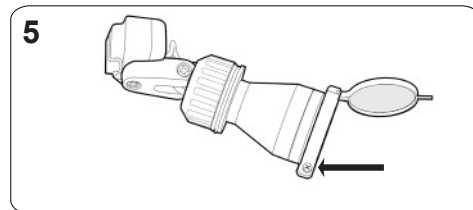
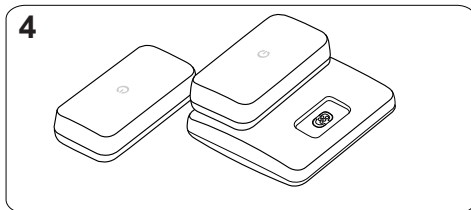
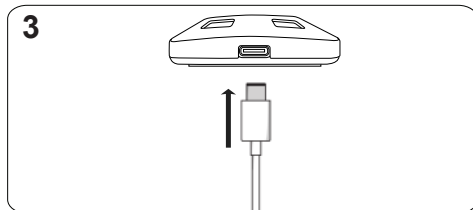
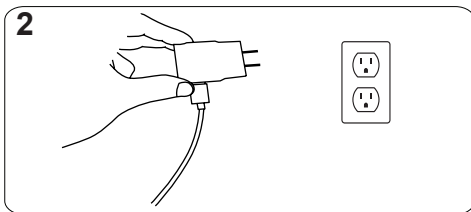
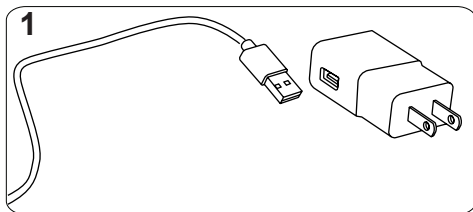

Product Specifications

Model:	REF 90803-001
Description:	Atom Plus Wireless LED Light
Lamp Illumination:	26,500 lux
Color Temperature:	6000K
Light Source:	LED Refractive Technology
Illumination Spot Size:	3.74 inches, fixed
Battery Pack Weight	22.5g
Dimensions of battery pack	55mm x 28mm x 15mm (W x D x H)
Battery Type	3.7V, 700mAh, Li-polymer
LED Light Module Weight:	15g
Headlight Construction:	Aluminum

Cleaning

CAUTION: DO NOT use solvents, lubricants, or other chemicals, unless otherwise specified.

To Clean the Atom Plus Light

NOTE: Avoid scratching or striking the front lens as a reduction in light transmission may occur.

1. Exterior surfaces of the Atom Plus Light can be cleaned using a gauze pad or cotton swab moistened with 70% isopropyl alcohol or mild soap. After cleaning, wipe the area with a lint-free soft cloth moistened with water to remove any residue from cleaning products.
2. DO NOT immerse or spray the Atom Plus Light, battery packs or charging pad with any liquids. Make sure no liquid comes in contact with the Atom Plus Light, electrical connectors, charging pad or battery packs.

Storage and Handling

CAUTION: ALWAYS store the equipment within the specified environmental condition throughout its useful life.

To ensure the longevity, performance and safety of this equipment, use of the composite carrying case or water tight packaging is recommended when storing or transporting this equipment.

Disposal / Recycle



WARNING: ALWAYS follow the current local recommendations and/or regulations governing environmental protection and the risks associated with recycling or disposing of electronic equipment and lithium batteries at the end of its useful life.

Symbol Definition

Symbol	Definition
	General Warning Sign (Yellow)
	Refer to Instruction Manual / Booklet
	Catalog number
	Lot number
	Medical Device
	Recycle of Li-Ion Battery (in Accordance with Local Laws)
	Light Intensity
	Power On/Off
	CE Mark indicating that the device complies with Regulation (EU) 2017/745 of the European Parliament and of the Council of 5 April 2017 on medical devices

World Headquarters
6305 Sandburg Road, STE 100
Minneapolis, MN 55427
+1 (651) 236-8857
sales@goenova.com

