



# Qubit™ LED Surgical Headlights

Qubit™ Cool LED Surgical Headlight

REF 80094-XXX

Qubit™ Warm LED Surgical Headlight

REF 80092-XXX

Instructions For Use

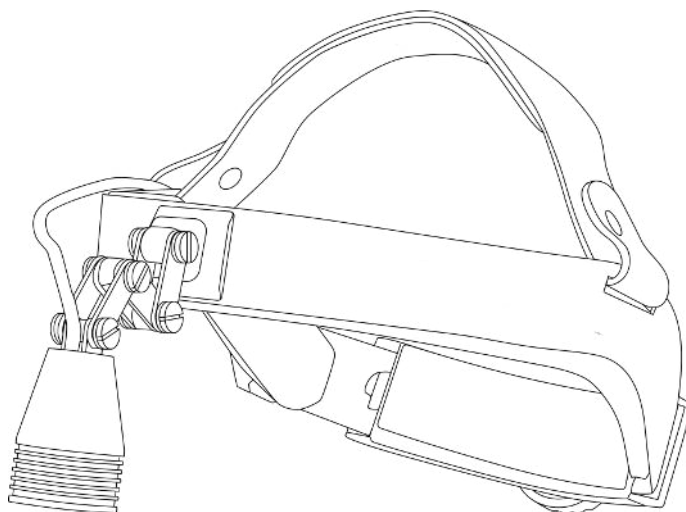

## Introduction

This *Instructions For Use* manual is the most comprehensive source of information for the safe and effective use of your product. This manual may be used by surgeons, dentists, veterinarians, or other healthcare professionals.

Keep and consult this reference manual during the life of the product.

The following conventions are used in this manual:

- A **WARNING** highlights a safety-related issue. ALWAYS comply with this information to prevent patient and/or healthcare staff injury.
- A **CAUTION** highlights a product reliability issue. ALWAYS comply with this information to prevent product damage.
- A **NOTE** supplements and/or clarifies procedural information.

If additional information, especially safety information, or in-service training is required, contact your Enova sales representative or call Enova customer service.

Trademarks not the property of Enova Illumination, Inc. are the property of their respective owners.

## Indications for Use

LED Surgical Headlight Systems are adjunct light sources used for illumination during clinical or surgical procedures in a medical setting.

## Contraindications

None known.

## Limitations of Use

None known.

## For Use With

Rechargeable PP4 and/or PP2 Power Pack and Extension Battery Cable (80303-001) or the Black Twist Battery Cable (80301-001), depending on the light's pigtail. See *Accessories* section.

## User / Patient Safety



### WARNINGS:

- Prior to operation, users of Enova's LED Surgical Headlight Systems should read and understand the operation manual for all equipment used in conjunction with the LED surgical headlight. Contact Enova or your local distributor for service and warranty information.
- DO NOT look directly into the LED surgical headlight when illuminated. DO NOT shine the light directly into the patient's eyes or face. Due to the intensity of light, eye injury may result. Patient's eyes should be appropriately protected in procedures involving the face or head.
- After a few minutes of operation, the headlamp housing may become warm to the touch. This is normal and functions to dissipate heat from the LED. Always use a surgical glove or sterile cloth to adjust the angle of the lens when in use.
- Use only Enova SUPPLIED BASE STATION, POWER PACKS, OR SINGLE CHARGERS. The use of other base stations or power packs may result in fire, explosion, or damage to the power packs or LED surgical headlight and will void warranty. The power pack must be powered off when charging. DO NOT USE OR STORE BASE STATION IN OPERATING ROOM OR SURGERY SUITE.
- All Enova LED surgical headlights are designed to be wireless. DO NOT USE THE LED SURGICAL HEADLIGHT WHILE POWER PACKS ARE CHARGING.
- DO NOT use the LED surgical headlight, power packs or base station in explosive gas environments.
- DO NOT autoclave, immerse or submerge in liquid, spray with liquids or leave the LED surgical headlight "on" when inside the composite carrying case as it will cause damage to the LED surgical headlight or may cause a fire.
- ALWAYS consult local regulations for the disposal of electronic products.
- DO NOT INTERCHANGE BATTERY CABLES. Use specified twist cable for correct LED surgical headlight, otherwise the LED surgical headlight will function abnormally and may damage the circuitry causing the light to fail.

**NOTE:** The expected service life of the headlight is five (5) years.

## Accessories

This section describes components that may be ordered to replace original equipment that is damaged, worn, or must be replaced.



### WARNINGS:

- Use only Enova-approved components and accessories, including power packs, unless otherwise specified.
- DO NOT modify any component or accessory, unless otherwise specified.

The following Enova-approved accessories can be sold in conjunction with the Enova Qubit LED Headlight:

DESCRIPTION	REF
Flip-Up Filter Set	86002-001
PP2 Power Pack	80200-001
PP4 Power Pack	80201-001
Power Pack Charging Base Station	80100-001
NA C-13 Power Cord	80150-001
NA C-13 Hospital Grade Power Cord	80150-002
Black Extension Battery Cable	80303-001
Black Twist Battery Cable	80301-001
Battery Belt	80500-001
Standard Comfort Pad Set	80400-001
Composite Carrying Case	80034-001

**NOTE:** For a complete list of accessories, contact your Enova sales representative or call Enova customer service.

## Features

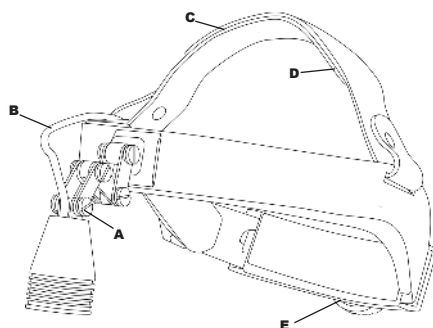

<b>A</b>	<b>Headlight Adjustment Bracket:</b> This bracket is used to adjust the light beam to fit coaxially to the line of sight.
<b>B</b>	<b>Surgical Headlight Power Cable:</b> This cable attaches to the battery cable to route power from the power pack to the LED light.
<b>C</b>	<b>Headband Adjustment Strap:</b> This strap is adjusted to provide a comfortable fit.
<b>D</b>	<b>Comfort Pads:</b> These removable pads provide a comfortable fit.
<b>E</b>	<b>Headband Adjustment Knob:</b> Customize the fit by turning the knob clockwise to tighten and counterclockwise to loosen the headband.

## Instructions



### WARNINGS:

- Perform recommended inspection and testing as indicated in the *Inspection and Testing* section.
- ALWAYS operate the equipment within the specified environmental condition values. See the *Specifications* section.
- This equipment is suitable to use in a professional healthcare facility environment.
- DO NOT cut or puncture the battery cable.
- ALWAYS turn the light source power off before connecting or disconnecting the battery cable to or from the LED surgical headlight.
- ALWAYS hold the strain relief near the end of the battery cable when connecting or disconnecting the battery cable from the light source (Figure 1).

### CAUTIONS:

- DO NOT scratch the LED surgical headlight lens.
- DO NOT stretch or kink the battery cable. Failure to comply will damage the battery cable and it will reduce the power transmission of the cable permanently.

**NOTE:** Headband position will vary from person to person depending on head size and personal comfort preferences.

## To Don an LED Surgical Headlight

### CAUTIONS:

DO NOT connect the battery cable to the power pack before donning the LED surgical headlight.

1. Connect the LED surgical headlight power cable to the appropriate battery cable (Figure 1). See the *Accessories* section.

**NOTE:** To disconnect the power cable, twist the connector sleeve back before separating the connector plug and receptacle (Figure 1).

2. Loosen the headband adjustment knob on the back of the LED surgical headlight (Figure 2).
3. Put the LED surgical headlight on your head (Figure 3) and turn the adjustment headband knob on the back to secure the LED surgical headlight (Figure 4a). Adjust top headband adjustment strap to comfort (Figure 4b). When using loupes, put them on after this step.

**NOTE:** Make sure the LED surgical headlight fits securely on top of your head and that the light is coaxial to your line of sight (Figure 5).

## To Use an LED Surgical Headlight

1. Plug the battery cable connector into the jack on the power pack (Figure 6).
2. Press the power button on top of the power pack (Figure 7).
3. Press the variable control buttons ("+" and "-") to adjust the light intensity on the power pack (Figure 8). See the *Troubleshooting* section if required.

## To Doff an LED Surgical Headlight

1. Turn the power pack off.
2. Disconnect battery cable from light/battery.
3. Loosen the headband adjustment strap on the top and adjust headband knob on the back of the LED surgical headlight and remove the LED surgical headlight from your head.
4. Clean after each use. See the *Cleaning* section. To clean the Power Pack, see the instructions for use supplied with the Enova Power Pack.

## Inspection and Testing



### WARNINGS:

- Only individuals trained and experienced in the maintenance of these medical devices should test and service this equipment.
- DO NOT use any equipment if damage is apparent or the inspection criteria are not met.
- DO NOT disassemble or service this equipment, unless otherwise specified.

**NOTE:** For service, contact your Enova sales representative or call Enova customer service.

INTERVAL	INSPECTION CRITERIA	ACTION
Before Each Use	Inspect equipment for damage, wear, or missing components.	If damage is apparent, replace the equipment
	Inspect power cord and battery cable for cuts or punctures.	
	Inspect headlight lens for scratches.	
	Inspect the power pack housing for cracks.	

**NOTE:** If any component must be discarded, see the *Disposal / Recycle* section.

# Instructions

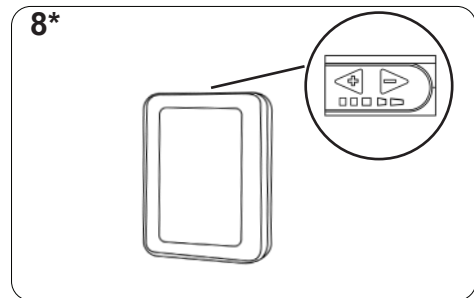
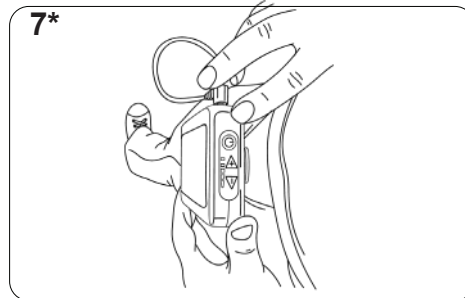
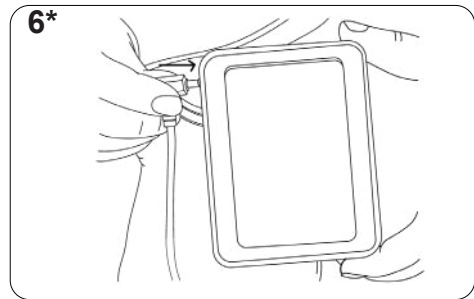
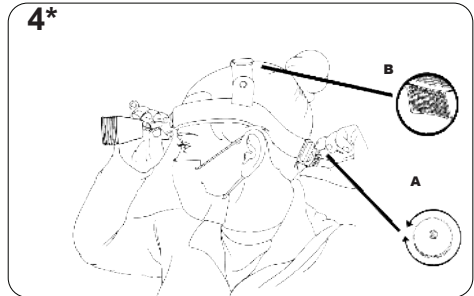
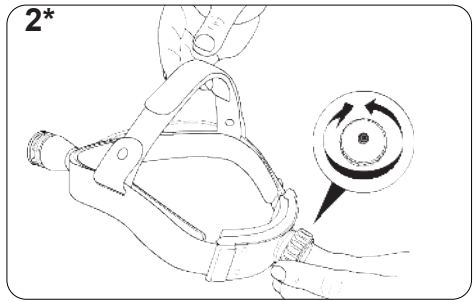
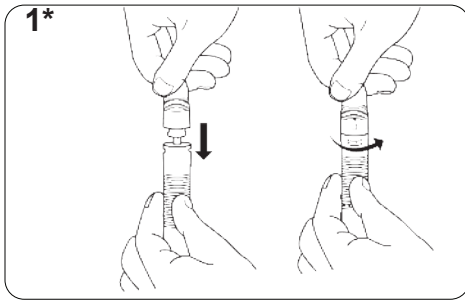

## Cleaning

### CAUTION:

- DO NOT use solvents, lubricants, or other chemicals, unless otherwise specified.
- DO NOT immerse or spray the LED surgical headlight, power pack or base station with any liquids, nor should any liquids be poured on the lens, lens housing or cable connections. Make sure no liquid comes in contact with the LED surgical headlight, electrical connectors, base station or power packs.

### To Clean the LED Surgical Headlight

**NOTE:** Lens - Avoid scratching or striking the front lens as a reduction in light transmission may occur.

1. Exterior surfaces of LED surgical headlight, headband, and comfort pads can be cleaned using a gauze pad or cotton swab moistened with 70% isopropyl alcohol or mild soap. After cleaning, wipe the area with a lint-free soft cloth moistened with water to remove any residue from cleaning products.
2. For proper hygiene, it is recommended to replace the comfort pads every 3-6 months. Users may order additional comfort pads from Enova or your local distributor. All comfort pads are treated with AEGIS® Microbe Shield.

## Storage and Handling

**CAUTION:** ALWAYS store the equipment within the specified environmental condition values throughout its useful life. See the *Specifications* section.

To ensure the longevity, performance and safety of this equipment, use of the composite carrying case or water tight packaging is recommended when storing or transporting this equipment.

## Disposal / Recycle



**WARNING:** ALWAYS follow the current local recommendations and/or regulations governing environmental protection and the risks associated with recycling or disposing of the equipment at the end of its useful life.

## Troubleshooting







**WARNING:** DO NOT service this equipment, unless otherwise specified. If you require service, contact your Enova sales representative or call Enova customer service.

PROBLEM	CAUSE	ACTION
The LED surgical headlight is flickering.	Battery cable may be damaged.	Try another battery cable. If flickering is resolved, dispose of original cable and replace it.
	Surgical Headlight power cable attached to headlight is damaged.	Test second battery cable. If it the headlight still won't work, send in for repair.
	The LED surgical headlight is damaged.	Replace the LED surgical headlight.
The LED surgical headlight does not turn on.	The power pack is not charged.	Replace the power pack with a fully charged one. Put the discharged power pack on the base station.
	The battery cable is damaged.	If power pack is fully charged, try another twist cable. If the LED surgical headlight turns on, dispose of the original cable and replace it.
	The LED surgical headlight is damaged.	Replace the LED surgical headlight.
The LED surgical headlight is shorting out.	The battery cable is damaged.	Try another battery cable. If it works, then replace the damaged battery cable.
	The LED surgical headlight is damaged.	Replace the LED surgical headlight.

**NOTE:** If any component must be discarded, see the *Disposal / Recycle* section.





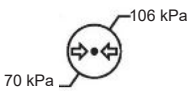
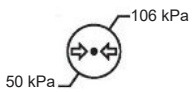

# Specifications





Model:	Qubit Cool (XLT-105F)	Qubit Warm (PLT-80F)
Description:	Qubit Cool LED Surgical Headlight	Qubit Warm LED Surgical Headlight
Lamp Illumination:	105,000 -210,000 lux	80,000 - 160,000 lux
Color Temperature:	6100K	4500K
Light Source:	LED Refractive Technology	
Illumination Spot Size:	Fixed spotlight at 2" (5.08cm), Optional Beam Adjustment Filter	
Headlight Weight:	7 oz (180g)	
Headlight Construction:	Aluminum	

Environmental Condition:	Operation	Storage and Transportation
Temperature:		
Humidity:		
Atmospheric Pressure:		

**NOTE:** See Enova Power Pack (REF 62002-001) battery specifications.

## Symbol Definition

Symbol	Definition (Indication Color)
	General Warning Sign (Yellow)
	Refer to Instruction Manual / Booklet (Blue)
	Catalog number
<b>QTY</b>	Quantity
	Lot number
	Medical Device
	Power On/Off
	Light Intensity Adjustment and Indicator

Symbol	Definition (Indication Color)
	Temperature Limitation
	Humidity Limitation
	Atmospheric Pressure Limitation
	Recycle: Electronic Equipment
	CE Mark indicating that the device complies with Regulation (EU) 2017/745 of the European Parliament and of the Council of 5 April 2017 on medical devices

**Word Headquarters**  
6305 Sandburg Rd, STE 100  
Minneapolis, MN  
(USA) 55427  
+1 (651) 236-8857

